

# Valance Selection and Reference

Page 1

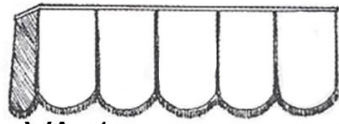

VA-1

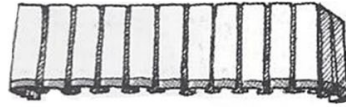

VA-2

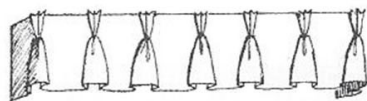

VA-3

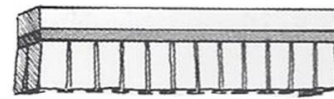

VA-4

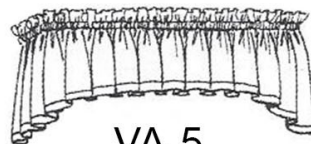

VA-5

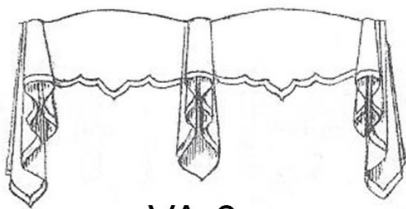

VA-6

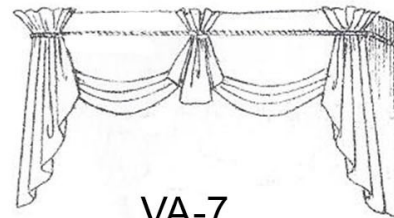

VA-7



VA-8

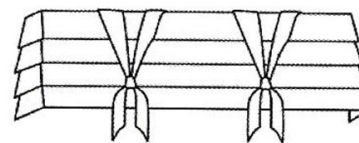

VA-9

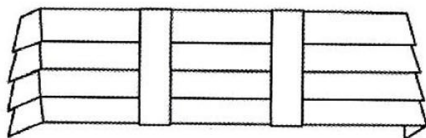

VA-10

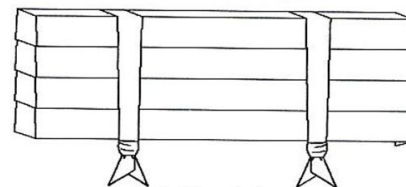

VA-11

# Valance Selection and Reference

Page 2

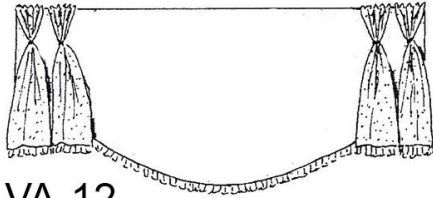

VA-12

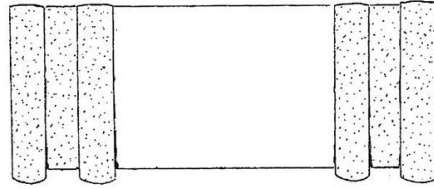

VA-13

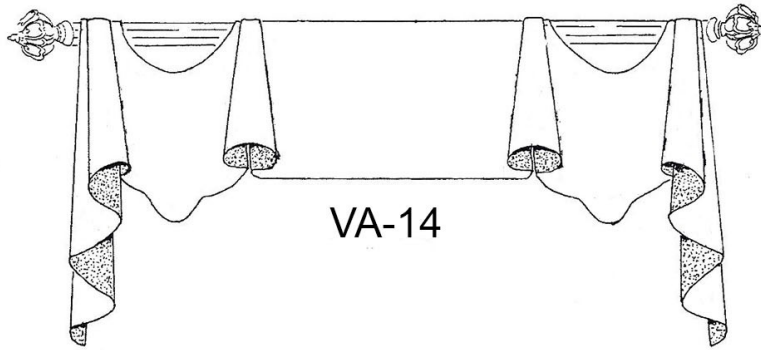

VA-14

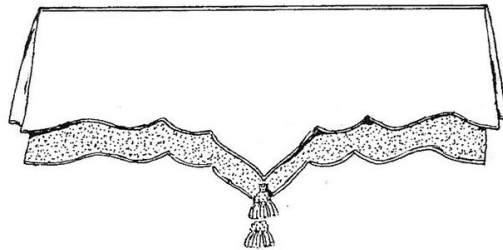

VA-15

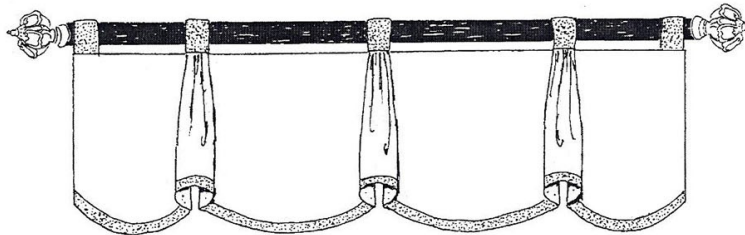

VA-16

# Valance Selection and Reference

Page 3

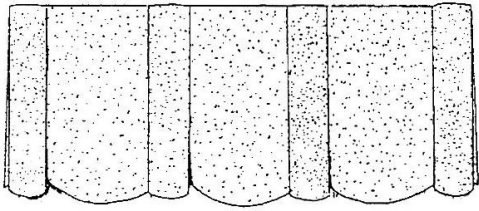

VA-17

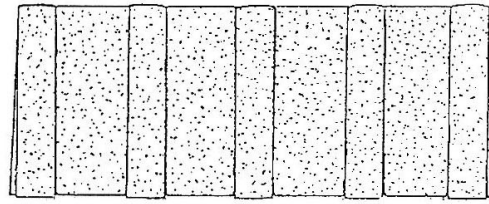

VA-18

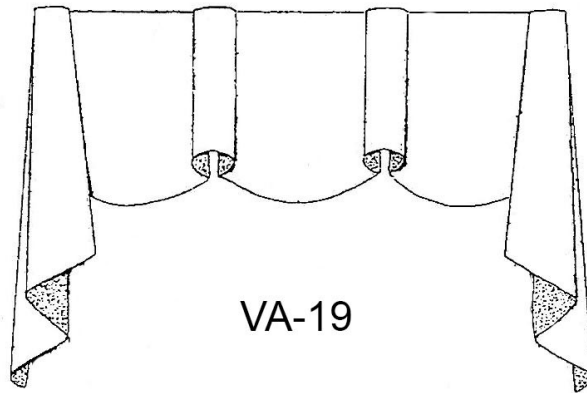

VA-19

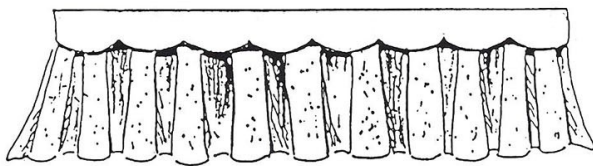

VA-20

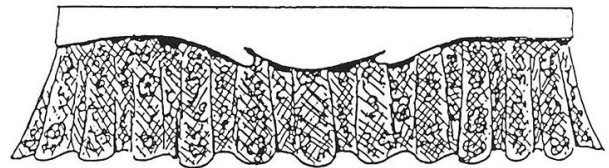

VA-21

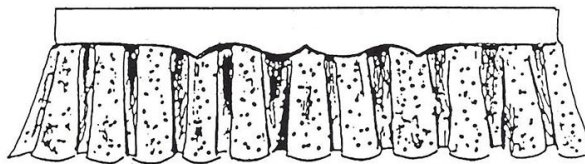

VA-22

# Valance Selection and Reference

Page 4

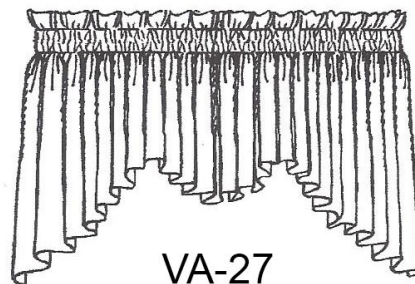
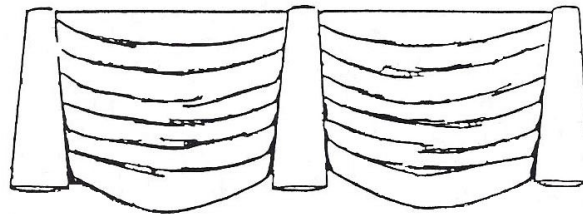
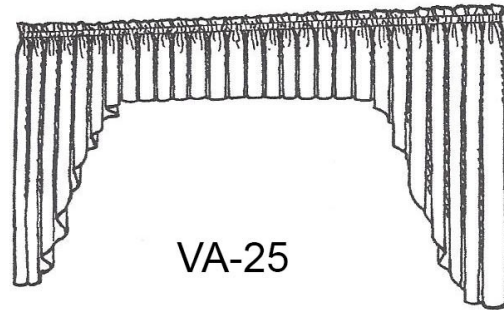
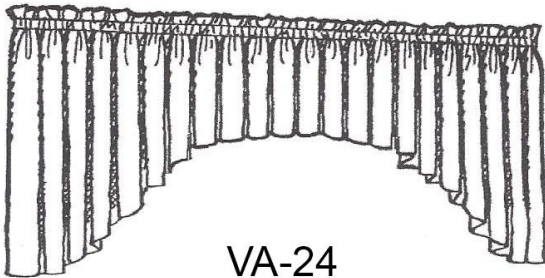
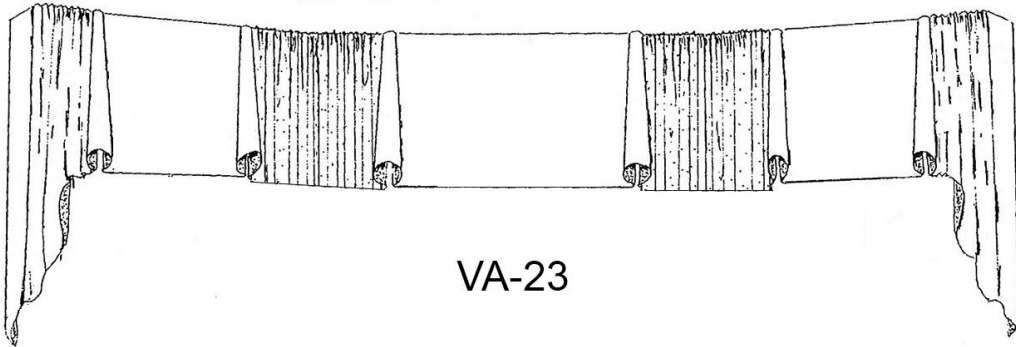

# Valance Selection and Reference

Page 5



VA-28

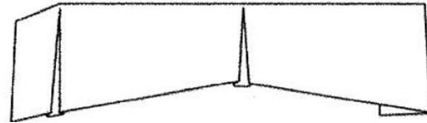

VA-29

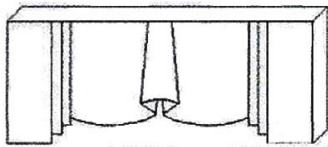

VA-30

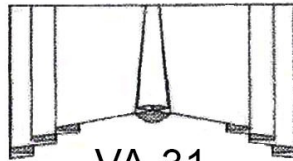

VA-31

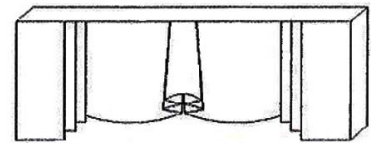

VA-32

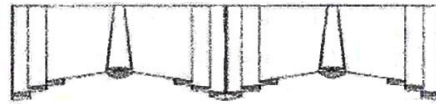

VA-33

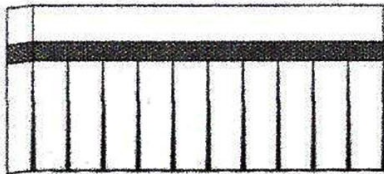

VA-34

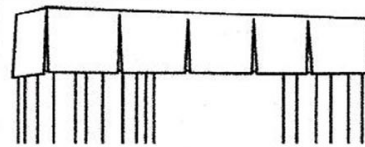

VA-35

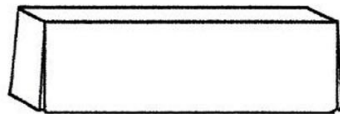

VA-36

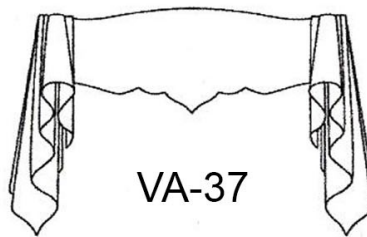

VA-37

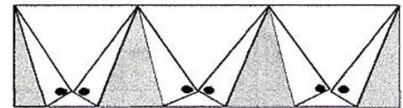

VA-38

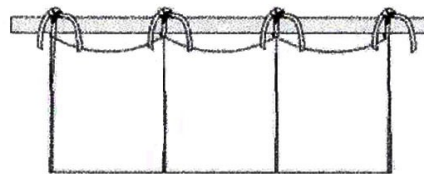

VA-39



# Valance Selection and Reference

Page 6

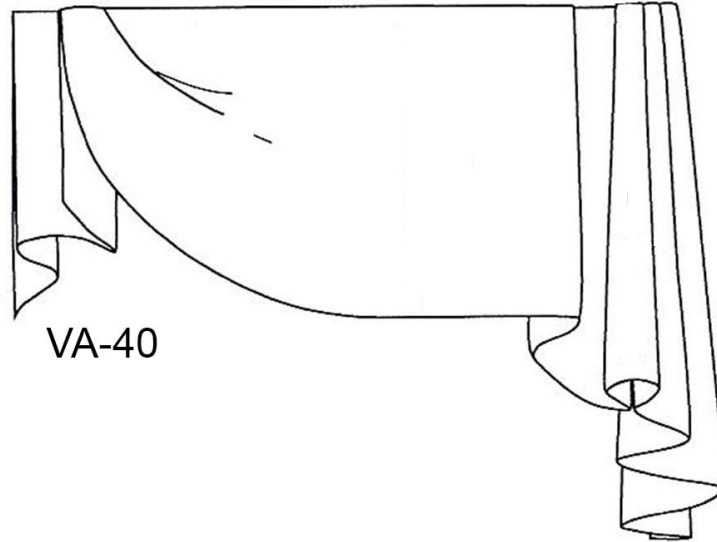

VA-40

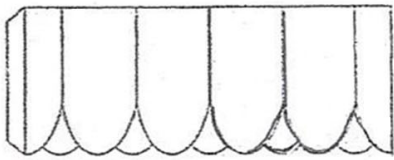

VA-41

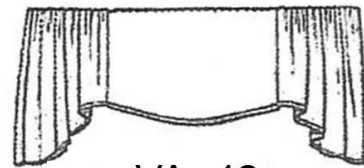

VA-42

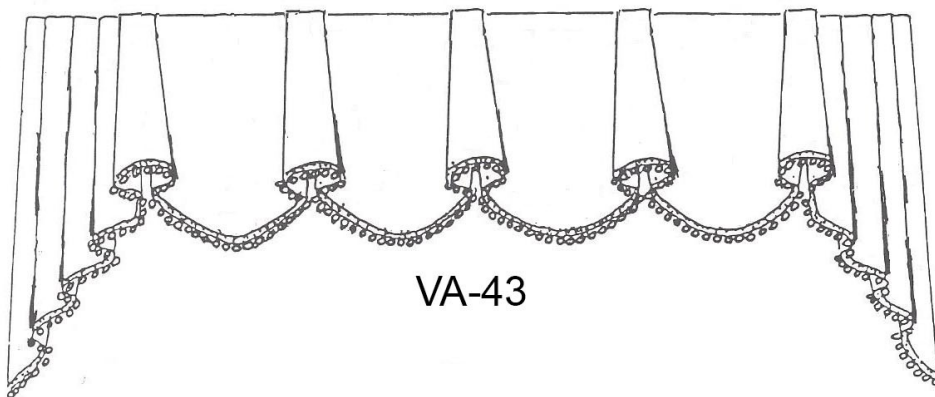

VA-43

# Valance Selection and Reference

Page 7

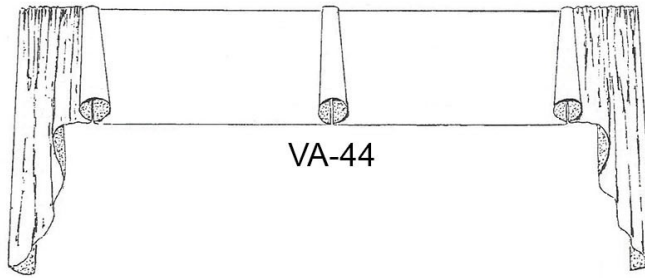

VA-44

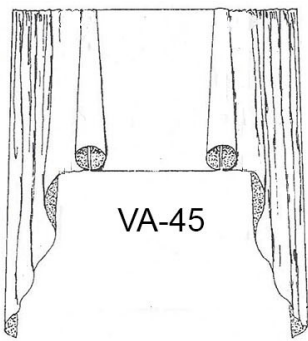

VA-45

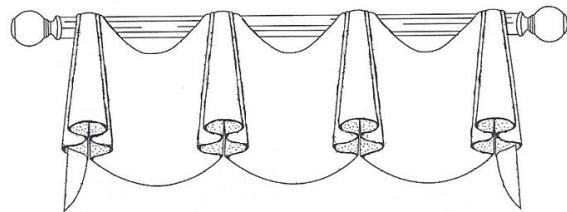

VA-46

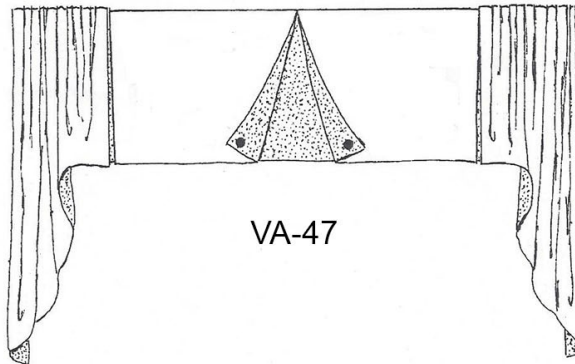

VA-47

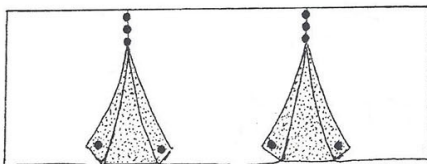

VA-48

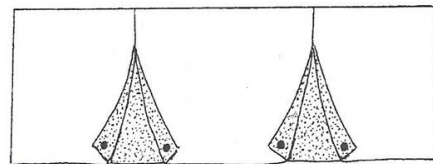

VA-49

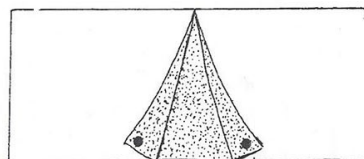

VA-50

# Valance Selection and Reference

Page 8

## Cascades



C-1



C-2



C-3



C-4



C-5

## Pelmets



P-1

Style: Bell  
Width: 3"-6"

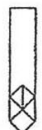

P-4

Style: Double Pleated  
Necktie  
Width: 3"-6"



P-7

Style: Inverted  
Necktie  
Width: 3"-6"



P-2

Style: Cone  
Width: 3"-6"



P-5

Style: Inverted Double  
Pleated Necktie  
Width: 5"-11"



P-7

Style: Inverted Pleated  
Necktie  
Width: 3"-8"



P-3

Style: Necktie  
Width: 3"-6"

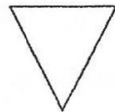

P-6

Style: Triangle  
Width: 12"



P-8

Style: Double Pleated  
Width: 9"-19"